

GENIUS

by



BM PRO

OWNER'S MANUAL

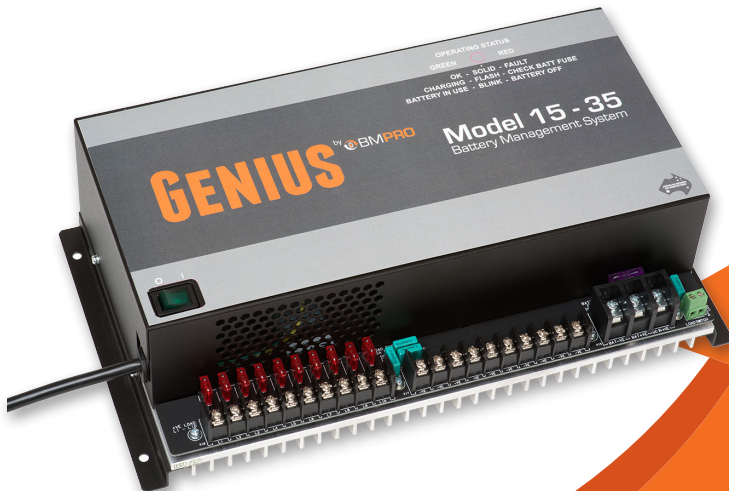

CONTENTS

Introduction	3
Safety Precautions	3
Accessories	4
About the Genius-II Power Supply	4
Names and Functions of Parts	5
Installing the Genius-II Power Supply	6
Personnel	6
Ventilation, Orientation and Thermal Considerations	6
Mounting	6
Mains Cable	6
Load, Battery and External DC Input Connections	7
Remote Load-Isolator Switch Connection	8
Battery Connection / Disconnection Procedure	10
Batteries	10
Paralleling Batteries	11
Storage	11
Deeply Discharged Batteries	11
Servicing	12
Functional Description	12
Functional Diagram	12
AC/DC Power Supply	12
Fault Protection	13
Fusing	13
Battery Charging Features	13
Battery Charging Management	13
Battery Charging Store Mode	14
LED Indicator	15
Specifications	16
After-Sales Service	16
Repairs and After-Sales Service	16
Warranty Terms and Conditions	17

Copyright © Setec 2014

Disclaimer

SETEC makes no claim as to the accuracy or suitability of the information contained in this manual. SETEC accepts no liability for any loss or damage, which may occur as a result of improper or unsafe use of its products.

Warranty is only valid if the unit has not been modified or misused by the customer.

INTRODUCTION

SAFETY PRECAUTIONS

Please read the Safety Precautions carefully before installing the power supply. Be sure to observe all precautions without fail.

After completing installation, conduct a trial operation to check for faults.

 WARNING	Failure to observe these instructions properly may result in personal injury, or loss of life.
Ensure that there is good ventilation from the battery area.	
This appliance is not intended for use by young children or infirm persons without supervision. Young children should be supervised to ensure that they do not play with the appliance.	
Batteries are electrically alive at all times and must be treated with extreme caution. They can supply high short circuit currents, even if they appear damaged.	
Take care that dropping or touching of metal objects onto the battery cell does not cause short circuits.	
Remove any personal metal adornment such as a chain, watch or ring, which could cause short circuits and personal injury.	

 CAUTION	Failure to observe these instructions properly may result in property damage or personal injury, which may be serious depending on the circumstances.
Refer to the installation section before operating. Correct installation is the most critical factor in ensuring the safe use of the power supply. If every consideration of these instructions has been satisfied the power supply will be safe to operate.	
Ensure that cable connections to batteries have the correct polarity and are protected against accidental short circuit.	
Ensure that the shrouding supplied with the battery is fitted to the terminals.	
Before servicing a battery, disconnect the power supply from the mains supply.	
Do not attempt to charge non-rechargeable batteries. Charging a nonrechargeable battery may result in the battery catching fire or possible explosion.	
Do not allow water or other liquids to enter the installation area.	

ACCESSORIES

Accessories provided with this product are:

- › Owner's Manual

ABOUT THE GENIUS-II POWER SUPPLY

The Genius-II has been designed for use in caravans and similar recreational vehicles, providing a DC power system with optional battery back up. The units operate from 240 Vac and provide an isolated 13.65 Vdc output at 35 A for powering the load and charging the caravan battery. All the necessary protection and operating features for the load and battery are provided. An optional DC input is also provided to enable battery charging and powering of the load from an external +13.8 V DC power source.

The unit is fully enclosed ready for direct wall mounting. All connections are at the base of unit providing convenient wiring and installation. User access to all load and battery fusing has been provided at the base of the unit.

The Genius-II is available in two different battery charge currents.

MODEL	BATTERY CHARGE CURRENT
GENIUS-II GENIUS-IIA GENIUS-IIN	15A
GENIUS-IIH GENIUS-IIHA GENIUS-IIHN	30A

Table 1: Genius II Models and their respective maximum battery charge current ratings

NAME AND FUNCTION OF PARTS

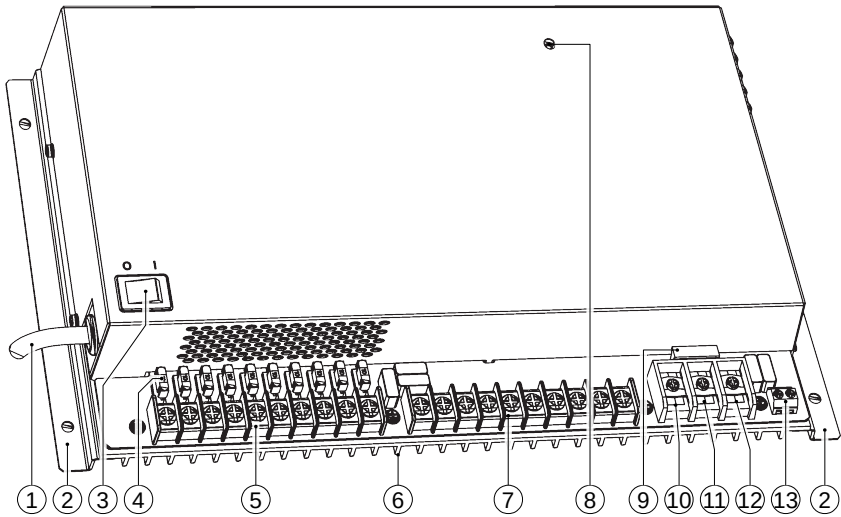

- | | |
|--|--|
| <p>① Mains Cable (permanently connected)
240 V input power for charging the caravan battery and powering loads</p> <p>② Mounting Bracket</p> <p>③ Illuminated Power Switch
240 V input power switch</p> <p>④ Load Fuses
Ten fuses for the 12 V loads</p> <p>⑤ Load Terminal Block, Positive Connection
Used for connecting the positive wire of the 12 V loads</p> <p>⑥ Heatsink Fins
Air flow past the fins removes excess heat from the unit</p> <p>⑦ Load Terminal Block, Common Negative Connection
Used for connecting the negative wire of the 12 V loads</p> | <p>⑧ Indicator
Multi-colour status indicator</p> <p>⑨ Battery Fuse
Fuse for caravan battery connection</p> <p>⑩ Battery Negative Terminal
Connection point for battery negative terminal and external DC input negative wire</p> <p>⑪ Battery Positive Terminal
Connection point for caravan battery positive terminal</p> <p>⑫ External DC Input Terminal
Connection point for external DC input positive wire</p> <p>⑬ Remote Switch Terminal block
Terminal block for connecting an optional remote switch. This switch is used to disconnect the loads from all power.</p> |
|--|--|

INSTALLING THE GENIUS-II POWER SUPPLY

PERSONNEL

Installation is to be carried out only by suitable qualified personnel.

VENTILATION, ORIENTATION AND THERMAL CONSIDERATIONS

The preferred orientation is with the cooling fins vertical and located such that there is a minimum of 80 mm free air space above and below them. This allows for the lowest operating temperature of the internal electronics and hence the highest reliability of the product.

The final enclosure must also provide adequate ventilation to the outside world (or larger internal cavity) to prevent excessive heating of the air within the enclosure.

The unit is rated to provide full power in both vertical and horizontal orientations with enclosure air temperatures up to 50°C.

Note: The enclosure air temperature can easily exceed 50°C if adequate ventilation is not provided.

The unit has over-temperature protection, meaning it will shut down if its internal temperature rises above a safe level. The unit will automatically restart once it has cooled to an acceptable level.



WARNING

Do not install unit in same compartment where flammable material such as petrol is stored.

MOUNTING

The Genius-II should be securely mounted to a suitably strong surface, using the two pre-drilled mounting brackets. Dimensional details are provided in Figure 1.

MAINS CABLE



WARNING

If the supply cord is damaged, it must be replaced by the manufacturer, its service agent or similarly qualified persons in order to avoid a hazard.

This is pre-cabled and fitted with AS/NZ mains plug ready for connection to an internal 240 V GPO. Ensure that the connection to the mains supply is in accordance with the national wiring rules, and that the earth connection is installed.

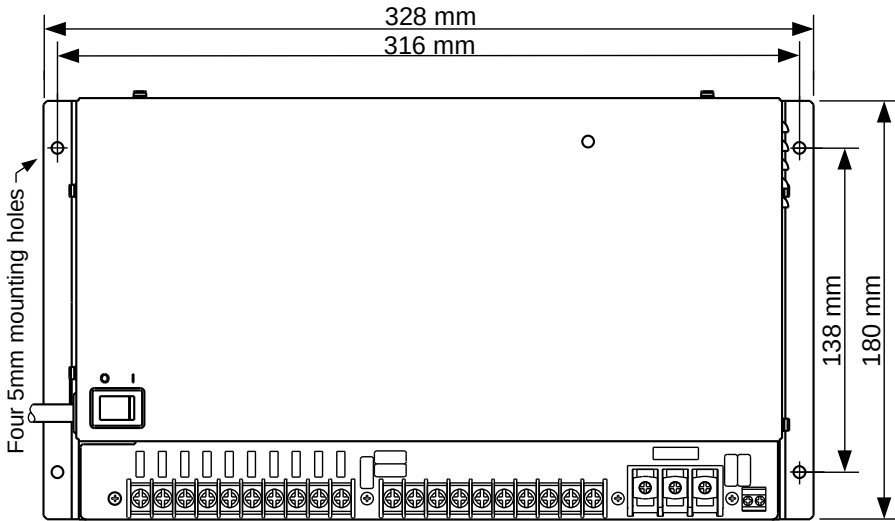

Figure 1: Mounting holes

LOAD, BATTERY AND EXTERNAL DC INPUT CONNECTIONS

All DC connections should be wired according to Figure 3 on page 9. A block diagram of the basic internal wiring of the Genius-II can be found in Figure 5 on page 13.

Wire Size

DC cables must be sized to carry the maximum full load current and to not exceed the system volt drop requirements. The following cable sizes are recommended.

When running wires, if they pass through panels or wall, ensure the wires are protected from damage by sharp edges. One option is to use cable glands.

CURRENT	MINIMUM WIRE SIZE
0 – 10A	1.0mm ² or 18 AWG
10 – 20 A	3.0mm ² or 14 AWG
20 – 30 A	5.5mm ² or 10 AWG

Table 2: Wire Size Recommendations

Load Connections

Up to 10 independently-fused loads may be connected. Loads are attached using the two 10-way terminal blocks.

Refer to Table 2 for wire size recommendations.

Where the wires connect to the terminal blocks, they should preferably be fitted with a spade terminal. In order to fit into the terminal block, spade terminals need to conform to the dimensions provided in Figure 2.

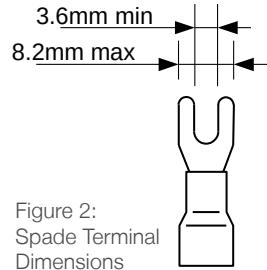

Caravan Battery Connection

Connect the caravan battery to the terminals shown in Figure 3 on page 9.

Refer to Table 2 for wire size recommendations.

The positive connection has an on-board fuse so no additional fusing is required.

External DC Input Connection

CAUTION Suitable fuse protection must be provided for the “DC In +VE” input. A fuse rating not exceeding 30 Amps must be used.

The power supply terminal “DC In +VE” provides an alternative option for powering of the load and charging of the batteries when mains voltages are not present. This input is to be powered from a suitable +12 V system (e.g. your Car). The voltage of this external DC power source should not exceed 14.8 V.

This input is diode isolated, so it is strictly an input; the Genius-II will never supply current to anything connected to this terminal. This is the preferred input for a car battery connection.

Note: The Genius-II does not provide battery charging management when operating in this configuration (no mains, DC power provided through the external input). In this configuration current and voltage control for the battery must be provided from the external source.

Solar Panel Connection

CAUTION Solar panels should not be directly connected; a solar panel voltage regulator must be fitted between solar panels and the battery.

Solar power should (through a series voltage regulator) be connected directly into the caravan battery circuit. See Figure 3 on page 9. The solar power may be wired directly to the caravan battery, or to the caravan battery connections on the Genius-II. Use whichever connection point is most convenient from a wiring perspective.

Note: A solar panel voltage regulator with maximum output voltage not exceeding 14.8 V must be used at all times. In some situations the led can blink randomly, this is because the solar charger voltage is greater than the charger voltage. This occurs only when the mains and the solar charger are both present.

REMOTE LOAD-ISOLATOR SWITCH CONNECTION

The Genius-II allows for remote control of the load connections. A pair of contacts are provided for connection to the external switch. When this switch is closed, all loads are disconnected from all power. Battery charging is not effected by this switch. The switch current when closed is less than 1 mA, so any convenient switch and wire size may be used.

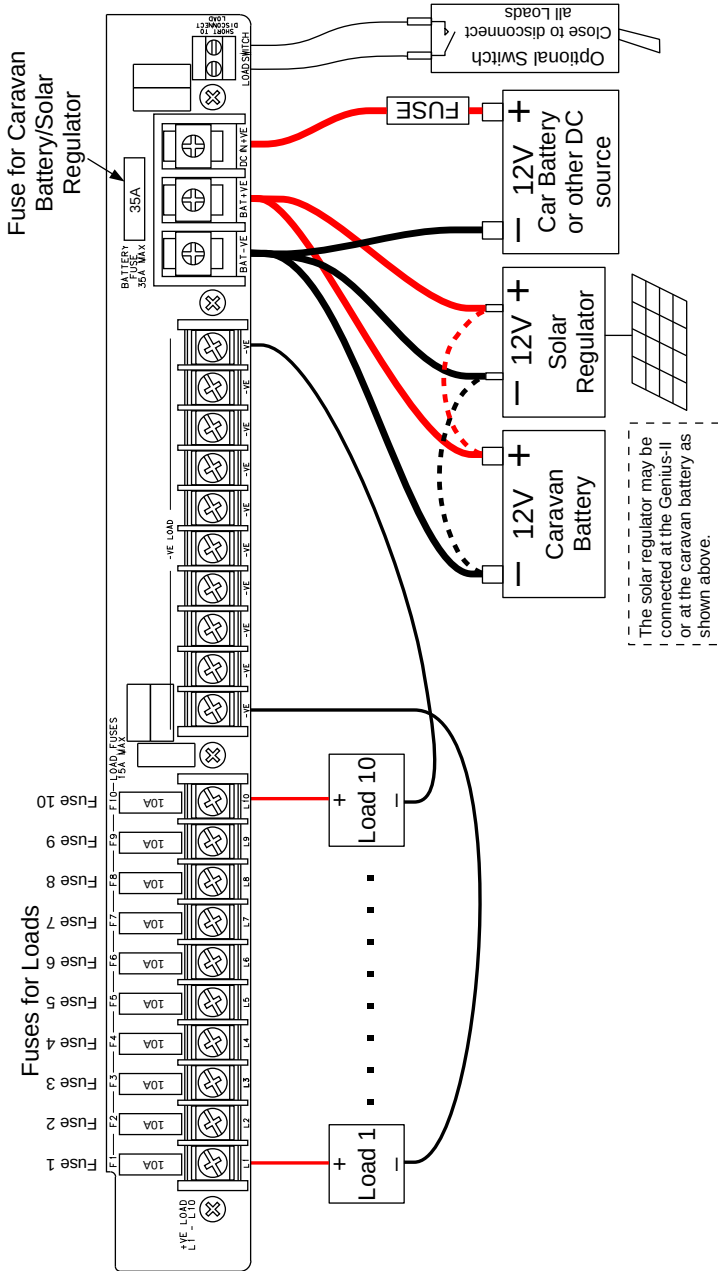

Figure 3: DC Wiring Diagram

BATTERY CONNECTION/DISCONNECTION PROCEDURE



WARNING

Sparks have the potential to cause an explosion should combustible gases be present. The following procedures are designed to minimise the risk of spark generation while connecting or disconnecting the battery.

Battery Connection Procedure

The caravan battery should be connected as per the following steps.

- 1 Remove mains power to the Genius-II
Turn off the power switch on the Genius-II
- 2 Disconnect all loads
Turn off all 12V equipment connected to the Genius-II
- 3 Connect the positive battery terminal
- 4 Connect the negative battery terminal

If the battery negative is connected to chassis, ensure a connection exists from chassis to the "Bat-VE" terminal of the Genius-II.

Battery Disconnection Procedure

The caravan battery should be disconnected as per the following steps.

- 1 Disconnect all loads
Turn off all 12V equipment connected to the Genius-II or disconnect the loads using the remove load-disconnect switch
- 2 Remove mains power to the Genius-II
Turn off the power switch on the Genius-II
- 3 Disconnect the negative battery
- 4 Disconnect the positive battery terminal

BATTERIES

Note: This battery charger is rated to charge lead acid batteries of up to 300 Ah capacity. Charging current is limited to 15 A or 30 A depending on the type of the model. Refer to About the Genius-II Power Supply.

When using batteries with this product always consult with the battery manufacturer for a detailed description of the installation, use and maintenance of the battery.

This product is suitable for charging 12 V Sealed Lead-Acid (SLA) batteries including Valve-Regulated Lead-Acid (VRLA) batteries, both Absorbed Glass Mat (AGM) and Gel Batteries.

CHARGE CURRENT	BATTERY CAPACITY	CHARGING TIMES
15 A	100 Ah	8 hours
	200 Ah	16 hours
30 A	100 Ah	4 hours
	200 Ah	8 hours
	300 Ah	12 hours

Table 3: These charge times are based on continuous charging with an initial battery voltage greater than 10.5V

PARALLELING BATTERIES

When paralleling batteries together, all the batteries **MUST** be

- of the same type, e.g. deep cycle battery
- of the same capacity, e.g. 100 Ah
- of the same manufacturer
- fully charged before connecting them together



Figure 4: Recommended wiring for connecting batteries in parallel



WARNING

Do not install battery in same compartment where flammable material such as petrol is stored.

STORAGE

If the caravan is to be stored for a long period of time, first fully charge the battery and ensure all loads are disconnected. Recharge the battery at least once every 6 months. Regular recharging will prevent the battery from becoming deeply discharged—a condition which can significantly shorten battery life.

DEEPLY DISCHARGED BATTERIES

This battery charger is not designed to charge deeply discharged batteries. Its effectiveness in charging such a battery is a function of the depth of discharge and the battery size. Bigger (higher capacity) batteries will be more troublesome in this respect.

In normal use a battery connected to the Genius-II should never become deeply discharged, so recharging it should never be a problem.

If a battery has become deeply discharged and the Genius-II will not charge it, remove the battery (see Battery Connection/Disconnection Procedure on page 10) and charge it with a stand-alone charger. Once the battery voltage has recovered to normal levels and the charge current is less than 15 A, it may be reinstalled.

SERVICING

This product contains hazardous voltages and energy hazards, which can result in death or injury. Only properly qualified service personnel may service it.

There are no internal user serviceable parts. Only the fuses located in the exposed terminal block area are user serviceable.

Isolate mains power, batteries and other DC input sources before servicing.

Fuses: Only the DC output load and battery fuses may be replaced

Fuse ratings: Loads: 32 V Automotive mini-blade Fuse, 15A maximum

Battery: 32 V Automotive regular blade Fuse, 35A maximum

Factory-fitted Fuse

Load fuses: 10 A Fuse

Battery fuse: 35 A Fuse

FUNCTIONAL DESCRIPTION

FUNCTIONAL DIAGRAM

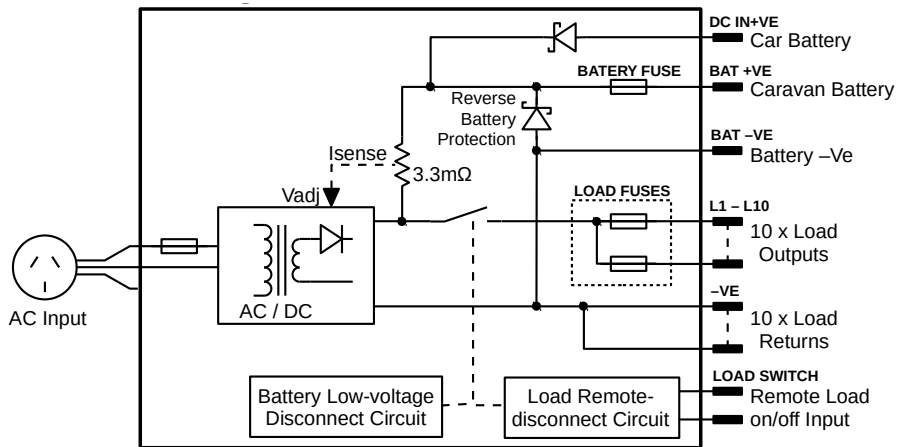

Figure 5: Functional Schematic

AC/DC POWER SUPPLY

This provides an isolated 13.65 V DC output for powering of the load and charging of the battery. Battery current is sensed and monitored by the power supply to limit the charging current to 15 A or 30 A maximum depending on the model. Refer to About the Genius-II Power Supply.

FAULT PROTECTION

The power supply provides automatic protection for overload including short circuit, over-voltage, over-temperature and reverse connected battery.

In overload, short circuit, and over voltage condition the power supply will shut down. It will then automatically attempt to restart every 5 seconds until such case that the fault is removed.

FUSING

Each load circuit and the caravan battery connection have been fused to provide fault protection and discrimination. Refer to the servicing section for fuse ratings.

BATTERY CHARGING FEATURES

The power supply (Genius-II) provides full battery management as per the following: The power supply is a three stage battery charger with Boost, Float, and Store charging modes to ensure long battery life. Charging current is limited to a maximum of 15 A or 30 A maximum depending on the model. Details of the charging process can be found in the Battery Charging Management section below.

The power supply is able to deliver 35 A maximum to the battery and loads on all models. For GENIUS-II, GENIUS-IIA and GENIUS-IIN, the 15 A battery charging rate is only possible if the load current is 20A or less. If the load current exceeds 20 A, the maximum battery charging current will be reduced accordingly. The same logic goes for GENIUS-IIH, GENIUS-IIHA and GENIUS-IIHN models, but have maximum battery charge current of 30 A.

Note that for the Genius-II to operate in the manner described above, all loads must be connected to load terminals, not directly to the caravan battery.

Low Voltage Disconnection of the batteries is provided to prevent deep discharge of the battery. Automatic reconnection occurs when battery voltage recovers. Battery Current Drain is less than 3 mA.

BATTERY CHARGING MANAGEMENT

To maintain the battery in a good state of health, an intelligently controlled charging algorithm is used. The purpose is to ensure that the correct voltages are applied to the battery terminals at the appropriate times throughout its usage cycle. The basics of the charging algorithm are detailed in Figure 6.

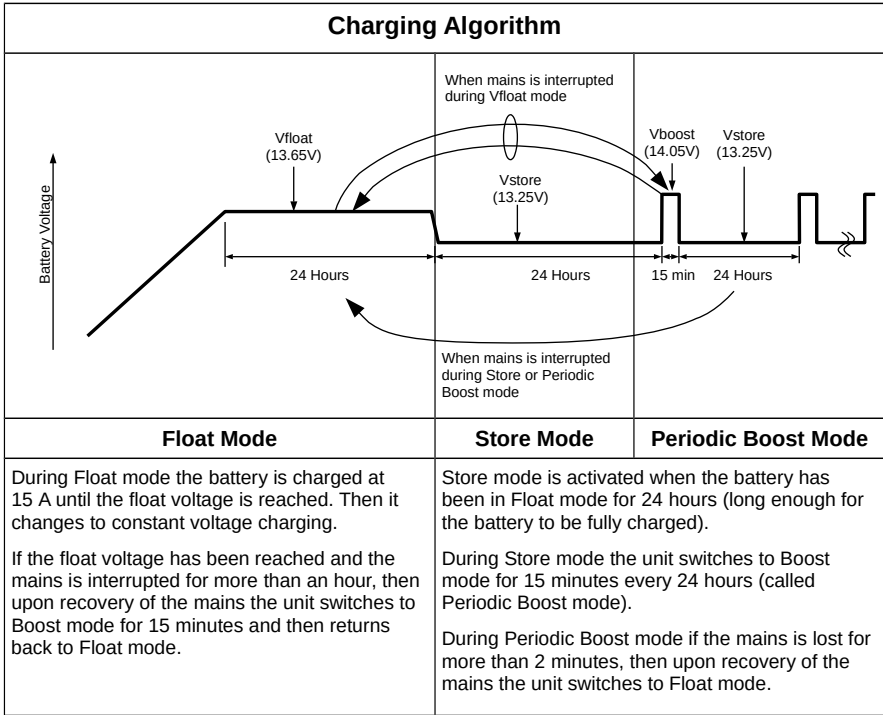

Figure 6: Charging Algorithm

BATTERY CHARGING STORE MODE

During Float charging (typically at 13.65 V) there is continuous charging current into the battery, sufficient in a long term charging situation to cause corrosion on the battery positive plate. To prevent this corrosion the charger utilises what is called a Storage mode, where the charging voltage is reduced to 13.25 V. In this mode the charging current is very small, usually less than the battery's self-discharge current.

If left continuously in Store mode, the battery would slowly discharge, so to prevent this the charger switches to Boost mode for 15 minutes once a day. This is sufficient to keep the battery fully charged.

The net result is a battery which can be left on charge indefinitely without the usual battery degradation problems from continuous charging.

LED INDICATOR

A multi-colour LED indicator is provided to indicate the following operating conditions:











Colour	Condition
Green (Solid) 	Mains present AND battery fully charged (battery charging current less than 1 A)
Green (Flash) 	Mains present AND battery charging AND loads connected
Green (Blink) 	No Mains and battery voltage above disconnect voltage (the battery is powering the loads)
Red (Solid) 	Mains present AND battery connected AND power supply in over-temperature shutdown mode
Red (Flash) 	Mains present AND battery fuse blown
Red (Blink) 	Loads disconnected via remote disconnection switch
Red and/or Green flashes of unspecified duration 	Output overload or Other unspecified fault

Table 4: LED Indications

Notes:

- a)  LED on continuously
- b)  Typically 0.25 second on, 0.25 second off
- c)  Typically 0.25 second on, 4 second off

SPECIFICATIONS

Specification	
Input Voltage	240 Vac nominal, $\pm 10\%$, 50/60 Hz The power supply will withstand a 5 minute, +15 % surge on the maximum nominal voltage
Input Surge	< 40 A (cold start)
Holdup Time	< 10 mS at full load current and over nominal input voltage operating range
Output Current	35 A Continuous (load + battery current)
Factory Set Voltage	13.65 V ± 0.1 V (Float voltage)
Load Regulation	< 2 %
Output Ripple Voltage	< 150 mV
Over Voltage Protection	< 17 V
Over Current Protection	35 A to 38 A (load + battery current)
Battery Current Limit	15 A \pm 1 A (GENIUS-II, GENIUS-IIA and GENIUS-IIN) 30 A \pm 3 A (GENIUS-IIH, GENIUS-IIHA and GENIUS-IIHN)
Battery Connect	11.5 \pm 0.2 V
Disconnect	10.0 \pm 0.2 V
Battery Drain	< 3 mA
Efficiency	> 84 %
Cooling Fan	Thermally controlled
Ambient	0°C – 50°C
Weight	3.7 kg
Standards	Safety: AS/NZS 60335.1, AS/NZS 60335.2.29 EMC: AS/NZS CISPR 22 Class A Compliance: ERAC

AFTER-SALES SERVICE



WARNING

Do not disassemble, modify, or repair the unit.
Doing so may result in electric shocks or fire.

REPAIRS AND AFTER-SALES SERVICE

Consult your BM PRO dealer.

WARRANTY TERMS AND CONDITIONS

Registering your BM PRO product is an important step to ensure that you receive all of the benefits you are entitled to. Please visit www.teambmpro.com to complete the online registration form for your new product today.

1) BM PRO goods come with guarantees that cannot be excluded under Australian Consumer Law. You are entitled to a replacement or refund for major failure and for compensation for any reasonably foreseeable loss or damage. You are entitled to have the goods repaired or replaced if the goods fail to be of acceptable quality and the failure does not amount to a major failure. The benefits under this Warranty are in addition to your other rights and remedies under a law in relation to the goods to which this Warranty relates (the Australian Consumer Law).

2) Setec, as the manufacturer of BM PRO goods warrants products against defects for a period of TWO year, commencing from the original date of purchase. Proof of purchase is required before you can make a claim under this warranty.

3) HOW TO PROTECT YOUR RIGHTS UNDER THIS WARRANTY: The GENIUS II is designed to be installed by a suitably qualified installer. You or your installer should carefully inspect the product before installation for any visible manufacturing defects. We accept no responsibility in addition to our consumer guarantee obligations where a product has been installed incorrectly.

4) This warranty does not extend to product failures or defects caused by, or associated with, but not limited to; failure to install or maintain correctly, unsuitable physical or operating environment, accident, acts of God, hazard, misuse, unauthorised repair, modification or alteration, natural disaster, corrosive environment, insect or vermin infestation and failure to comply with any additional instructions supplied with the product.

5) Setec may seek reimbursement of any costs incurred by them when a product is found to be in proper working order or damaged as a result of one or more of the warranty exclusions mentioned in point 4 of this statement.

6) To enquire or make a claim under this warranty, please follow these steps:

a) Prior to returning a BM PRO product, please contact Setec on +61 3 9763 0962 to obtain a Return Material Authorisation (RMA) number

b) Package and send the product to: BM PRO Warranty Department, 19 Henderson Road, Knoxfield, VIC 3180. Please mark RMA details on the outside of the packaging

c) Please ensure the package also includes: a copy of the proof of purchase, a detailed description of the fault and your contact details including phone number and return address

7) Setec will not be liable for any costs, charges or expenses incurred in the process of returning a product in order to initiate a warranty claim

NOTES

NOTES



THE BM PRO BATTERYCHECK



The BatteryCheck is an easy to install device that sets a new standard in battery management systems. This innovative product connects to your deep cycle battery and communicates wirelessly with smart phones. The BatteryCheck provides real time battery management data that allows you to effectively manage remaining battery energy via a simple to use app.

Key features

- > Communicates via Bluetooth with smart phones
- > Free downloadable app via Google Play and App Store
- > Instant real time data - view information including volts and amps, time remaining, temperature, battery status, state of charge and battery health
- > Easy installation – no mechanical expertise required
- > Works with multiple batteries when in parallel (7Ah-800Ah Battery Bank)
- > Internal shunt capacity - 80 amps continuous
- > Set automatic alarm warnings via app
- > Compatible with any deep cycle 12 or 24V Lead Acid, AGM and Gel 7Ah-800Ah battery

**A WORLD FIRST, INNOVATION
PATENTED PRODUCT SHOWCASING
THE LATEST TECHNOLOGY IN
WIRELESS BATTERY MANAGEMENT**



BM PRO - 19 Henderson Road, Knoxfield 3180, Victoria, Australia
Phone +61 3 9763 0962 | Fax +61 3 9763 8789
Email sales@teambmpo.com | Web www.teambmpo.com

SWITCH OFF. POWER UP.